

Kailux

Last Update : 2023 . 11

Code
E0159-70S40Z000

Technical data

LED Source	SMD
Luminous Flux (lm)	8811(4000K)
Power (W)	70
Luminous efficiency (lm/W)	125
Beam angle (°)	Symmetry
Color Temperature (K)	4000
CRI	≥80
Installation	-
Dimension (mm)	600 x 757 x 4000
Housing	Diecast aluminium body, Stainless steel screws, Silicone seal gaskets
Diffuser	Polycarbonate
Reflector	-
Optic	-
IP rating	65
Finish Color	Dark gray powdercoat finish
Electrical Data	AC 220~240V, 50~60 Hz
Control	-
Certification	KS, 고효율

Drawing

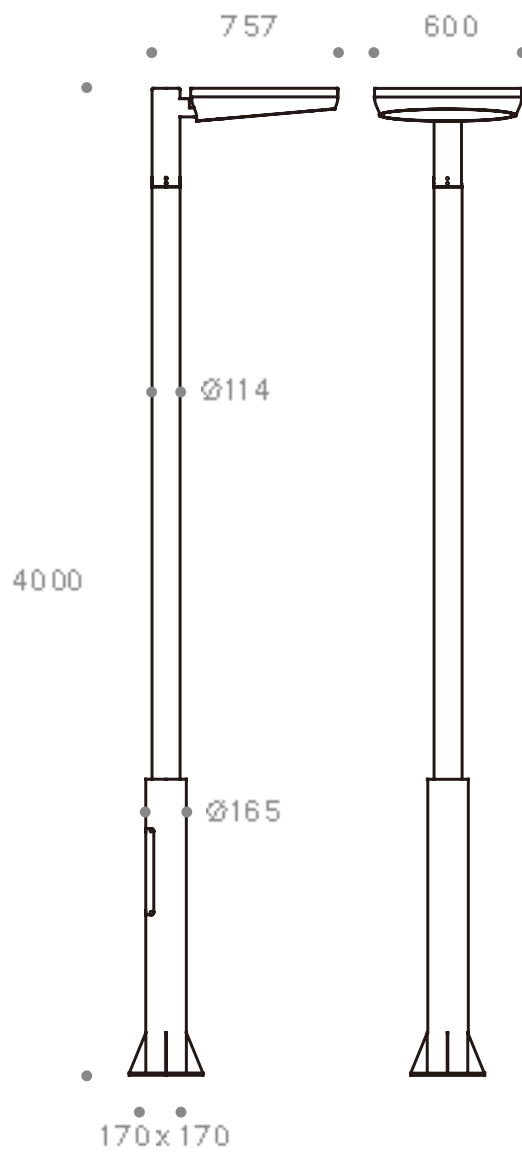

Photometric Data

Condition 70W . 4000K . 8811lm

